

*A few projects by Michael Davis
Engineering Design, Industrial Design, Product
Development*

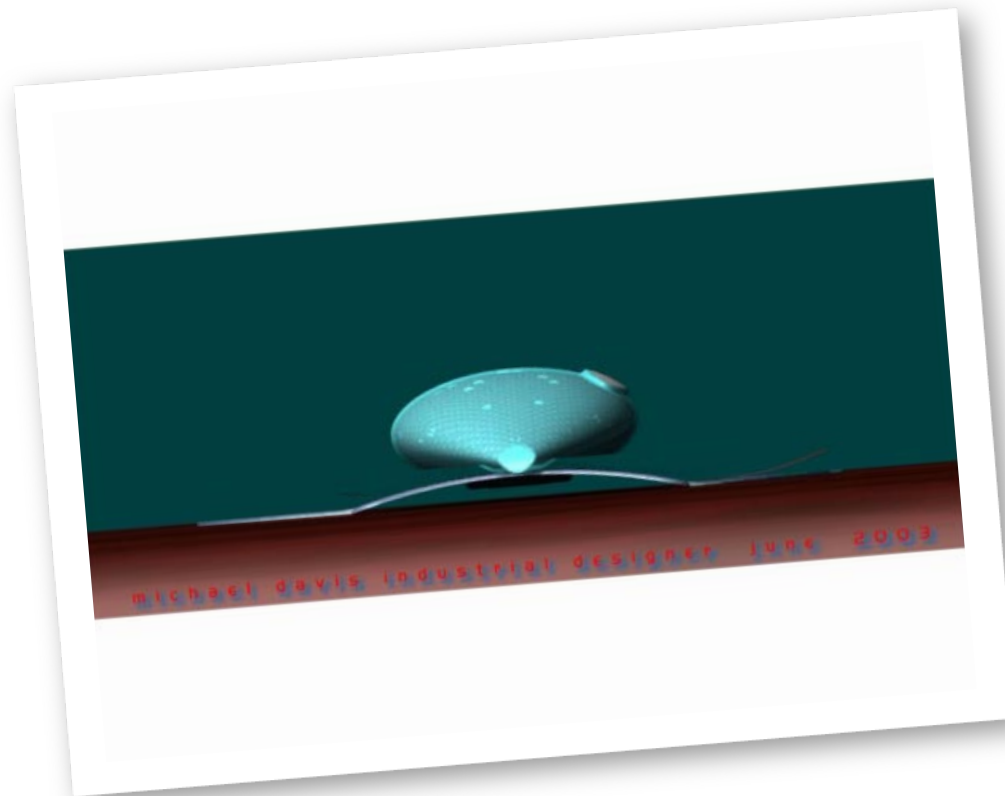



House Mover Dual Tractor
Control Center
Martinez & Turek for Rhodes
Housing
2008



Exploded view, sheet metal parts

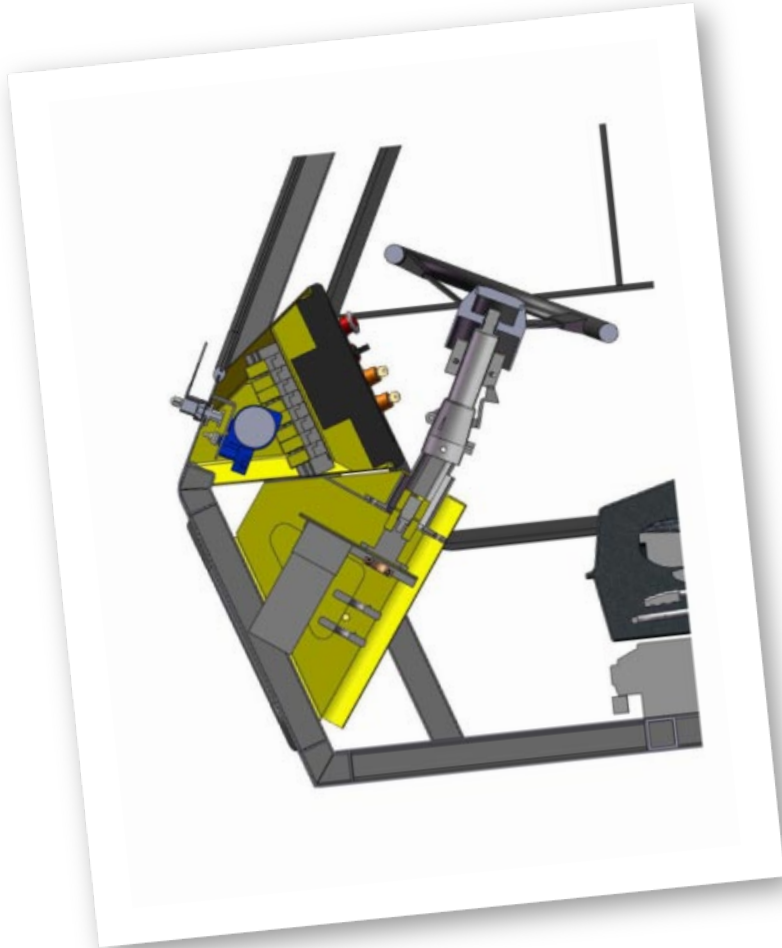

Cab Enclosure Steering Control assembly

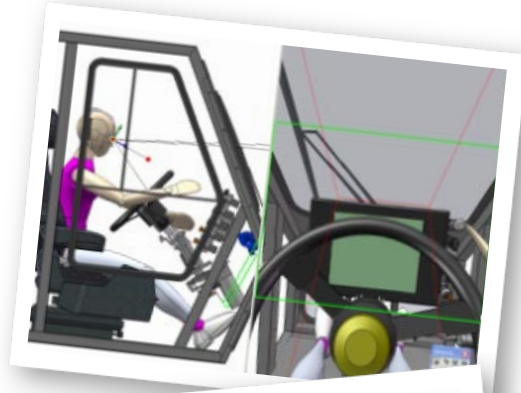

Human Factors Evaluation



Human Factors Evaluation



Human Factors Evaluation

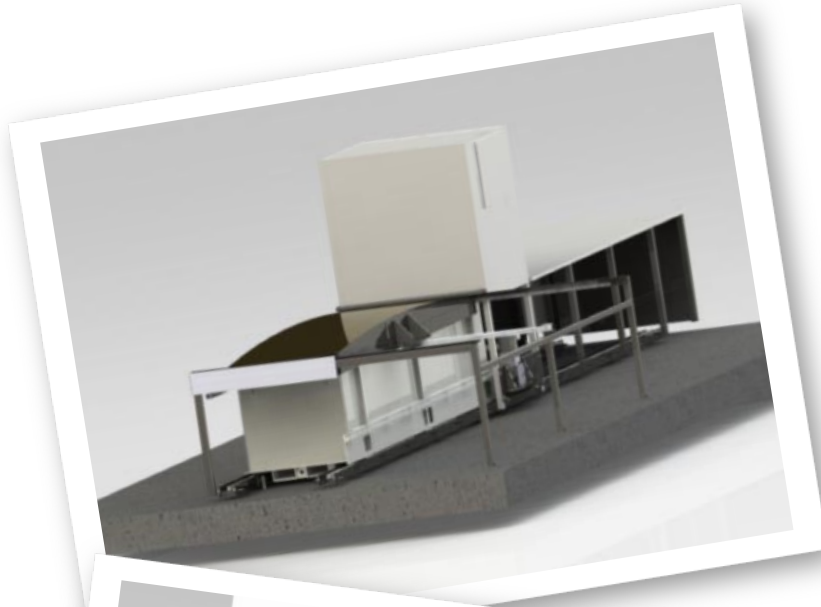

Tubing XRAY System for manufactured part xray analysis.
Michael Davis did 90% of the engineering design, all of the computer modeling and part development, vendor management for fabrication, actuator selection and design integration, etc. Approximately 300 parts, 50 assemblies.
Willick Engineering,
Summer of 2011

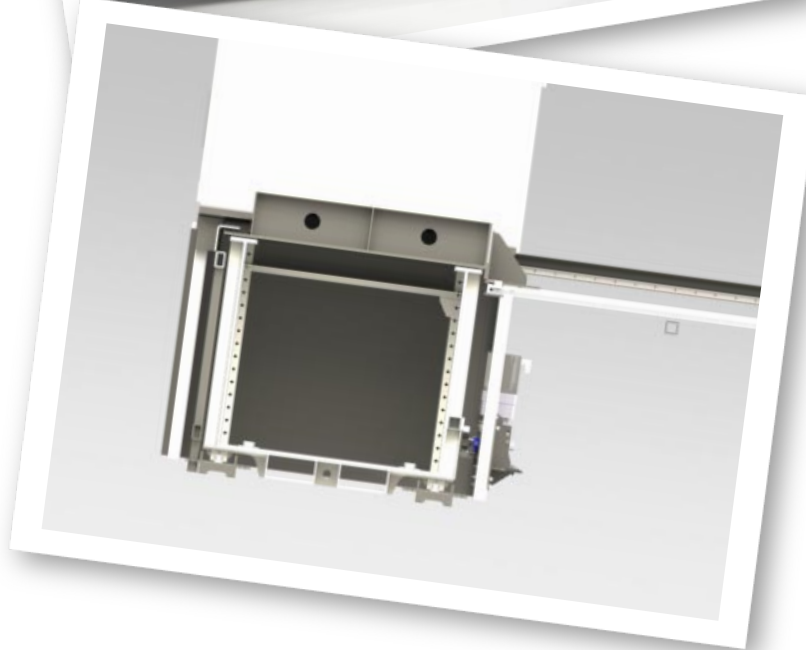

Section view through the sliding cart and cover

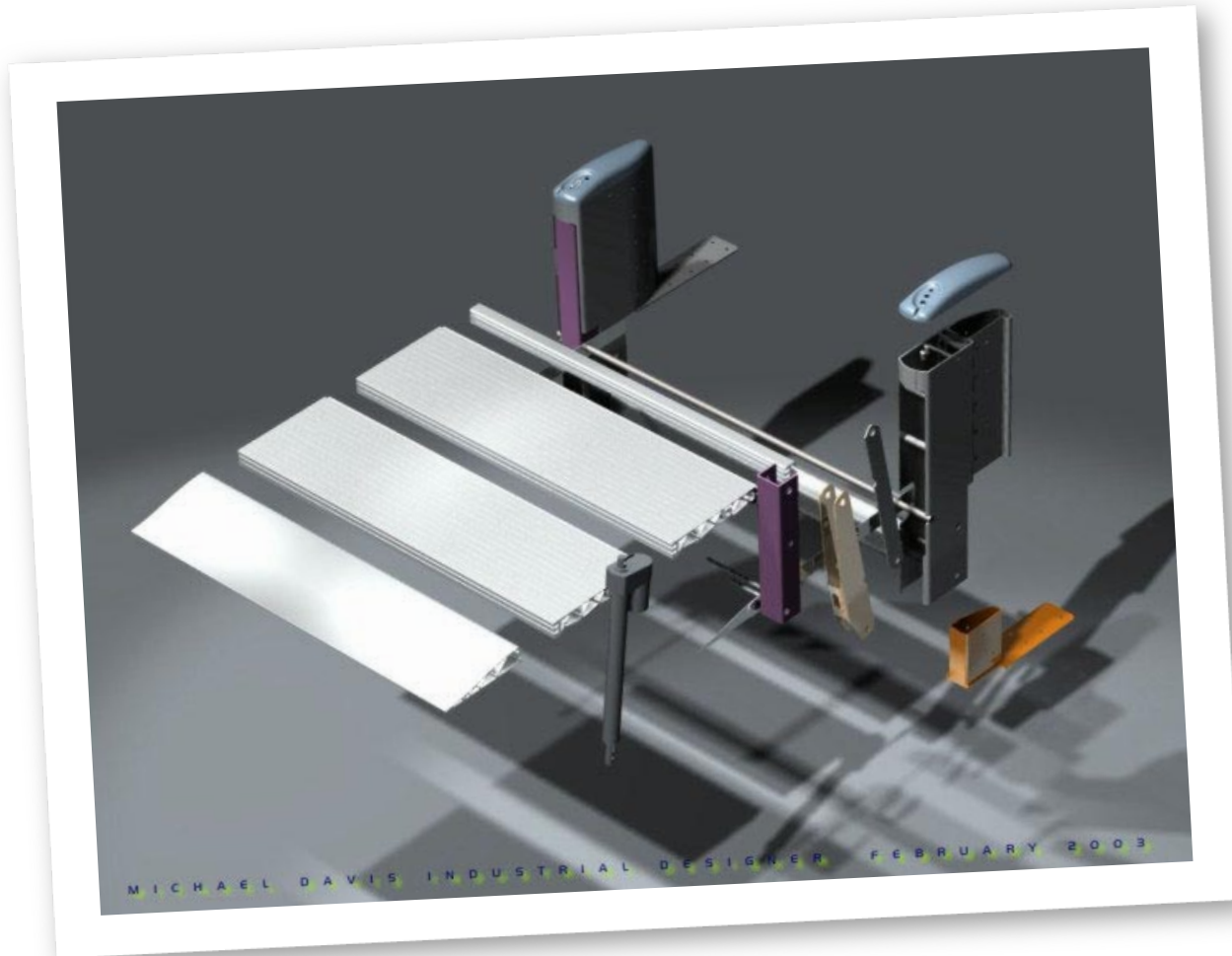

Lift Gate design for Maxon Lift.
Consumer truck application.
Michael Davis did all the original concept work, assembly and part development, design and engineering, actuator selection for this concept set.
2004



Lift Gate design for Maxon Lift.
Consumer truck application.
Exploded view, one side of actuator system.

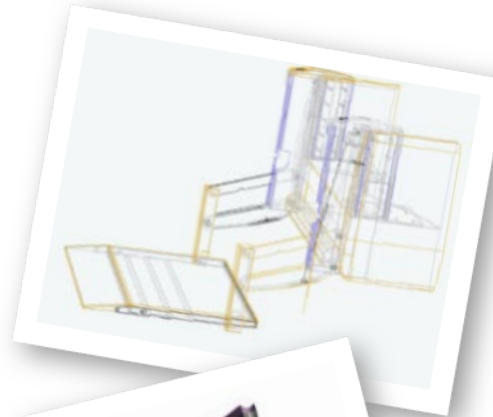

Lift Gate design for Maxon Lift.
Consumer truck application.



Lift Gate design for Maxon Lift.
Consumer truck application.

One side of actuator system.



Lift Gate design for Maxon Lift.
Consumer truck application.

Control Panel, concept A

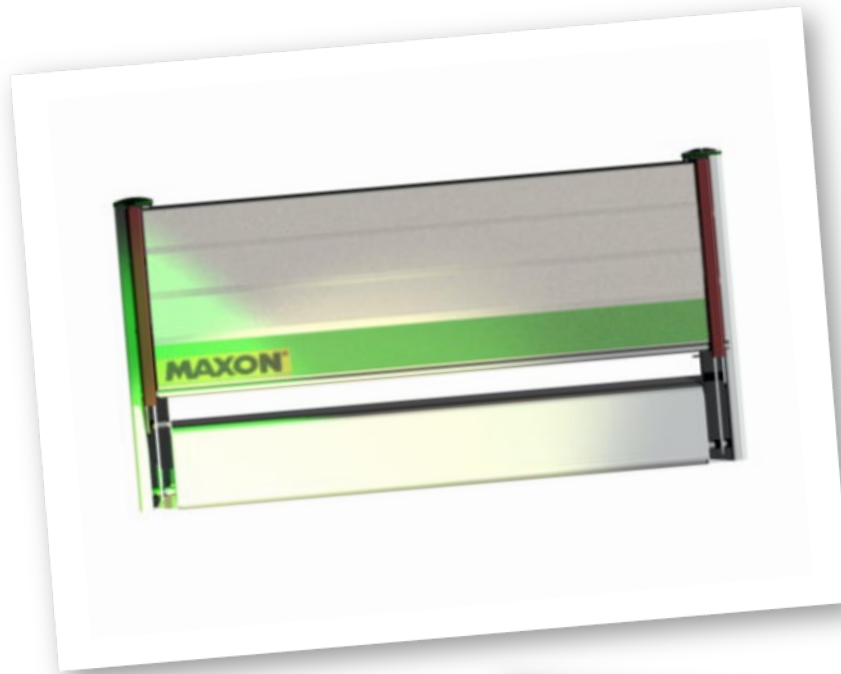

Concept A-1

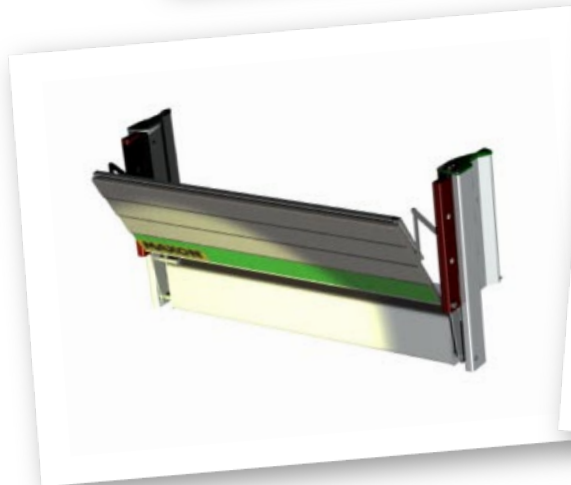

Concept A-1

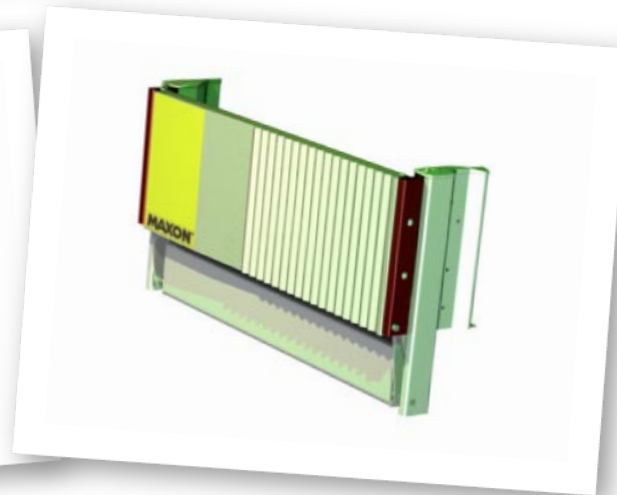

Concept A-2

The future of truck body design,
Morgan Truck Bodies
2000

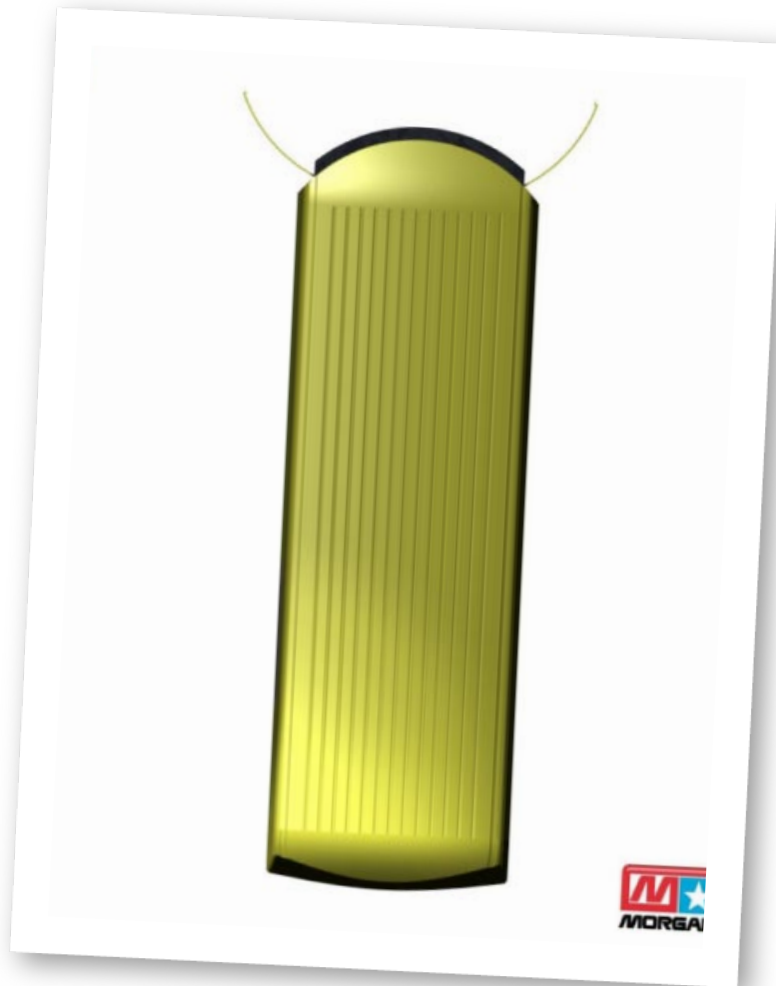

The future of truck body design,
Morgan Truck Bodies
2000

Top View, Truck Body concepts



The future of truck body design,
Morgan Truck Bodies
2000



Splash and face protection,
medical markets,
Moldex Metric
2005

Sample only. Final design is
NDA locked.

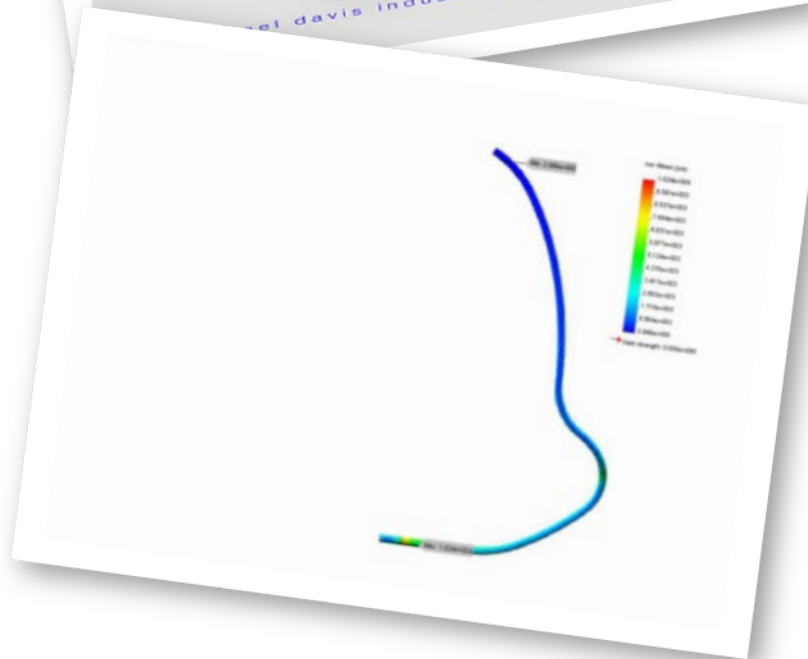

Splash and face protection,
medical markets,
Moldex Metric
2005

FEA evaluation of one of the
concepts

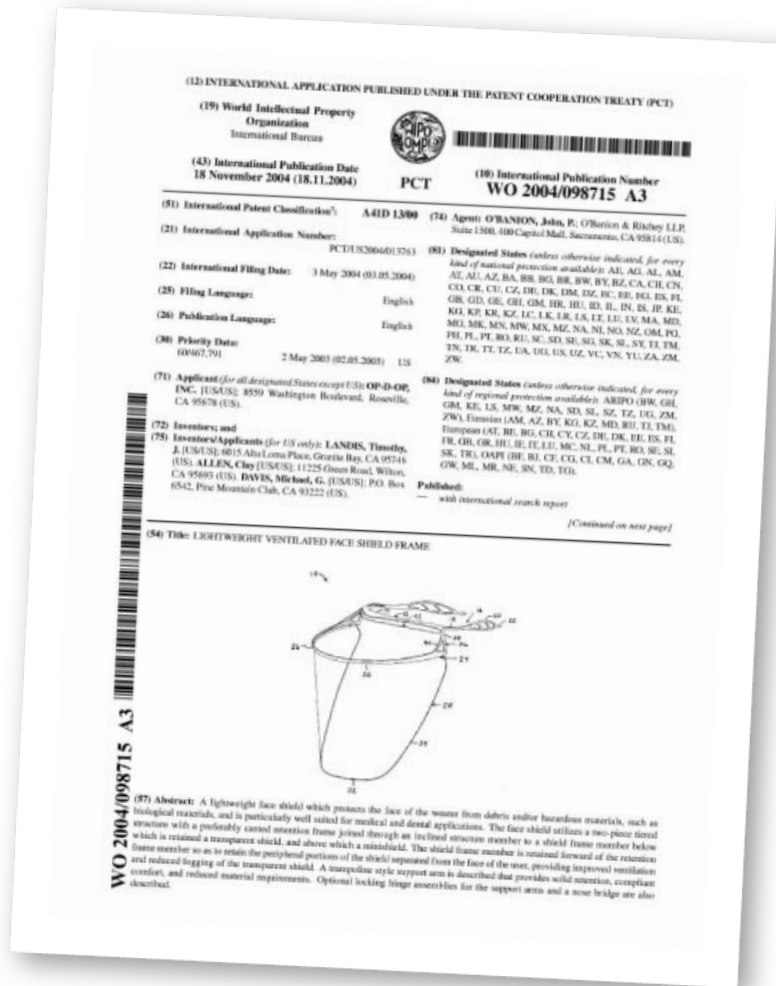

Patent,
Splash Protection,
Dental Markets,
OPDOP

Splash Protection,
Dental Markets,
OPDOP

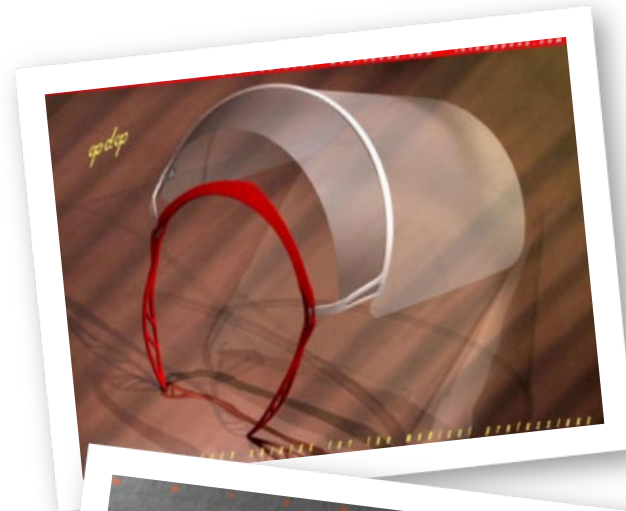

Splash Protection,
Dental Markets,
OPDOP



Sun Visor last
Opdop
2002



Sun Visor last
Opdop
2002



Sun Visor last
Opdop
2002

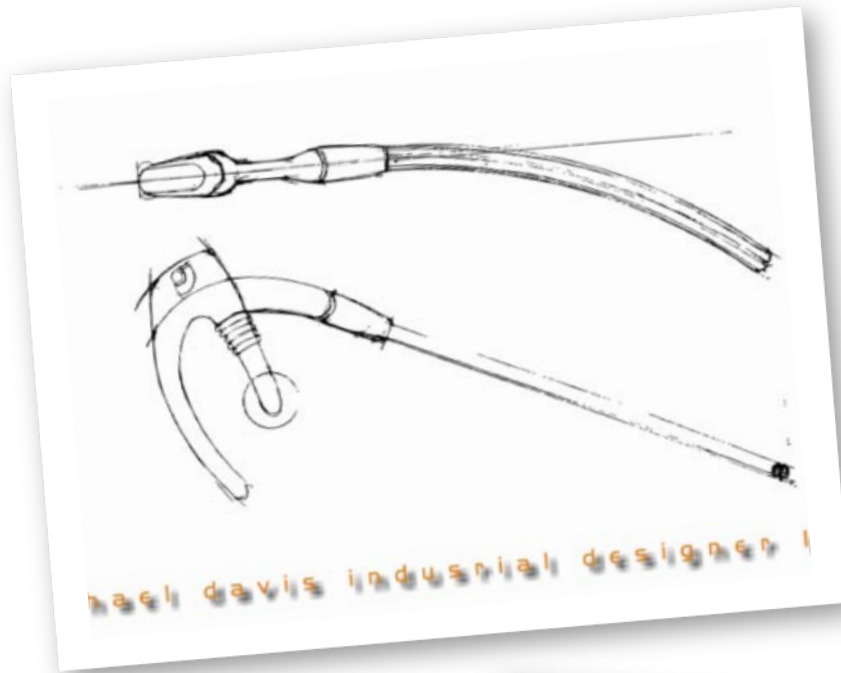

Plantronics Inc.
Headset Design, Headset Concept
re patent
1992

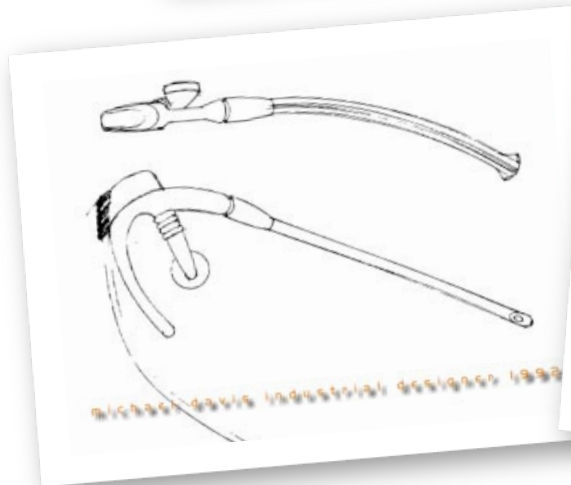

Plantronics Inc.
Headset Design, Headset Concept re patent
1992



Plantronics Inc.
Headset Design, Headset Concept re patent
1992

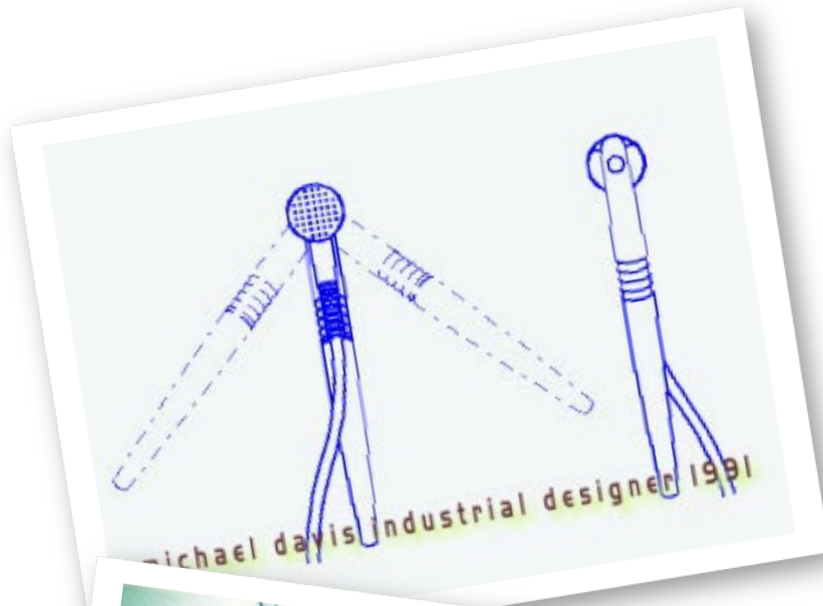

Plantronics Inc.
Headset Design, Headset
Concept
First concha based headset
concept
1992



Headset amp box design
concepts, foam
Plantronics, 1992



Door Chime, Home Depot, Ace Hardware
SolidWorks Model,
Heath Zenith, 1999



Door Chime, concept
SolidWorks Model,
Heath Zenith, 1999



Door Chime, Home
Depot, Ace Hardware
SolidWorks Model,
Heath Zenith, 1999



Door Chime, concept
SolidWorks Model,
Heath Zenith, 1999



Door Chime button design
Heath Zenith
1998



Door Chime
Heath Zenith,
1998

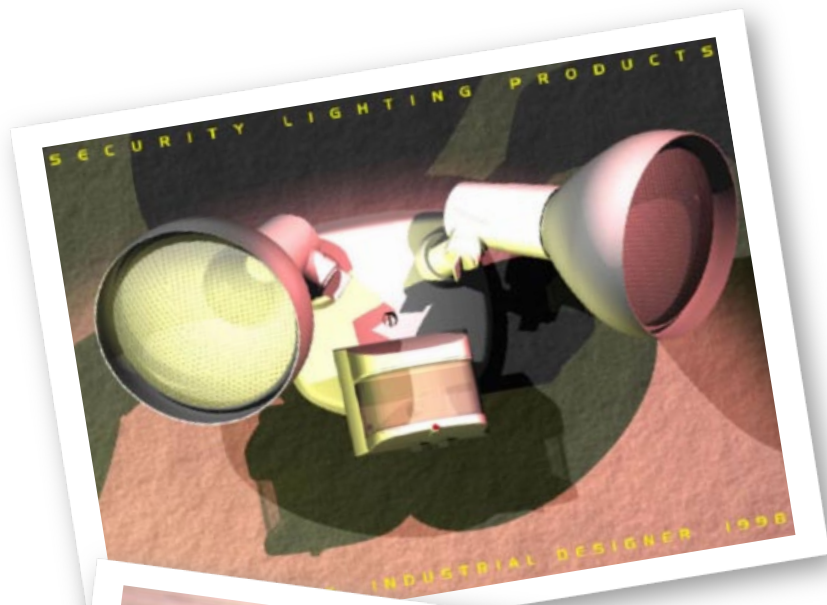

Motion Light
Heath Zenith for Lowes,
Home Depot
1998



Motion Light
Heath Zenith for Lowes,
Home Depot
1998

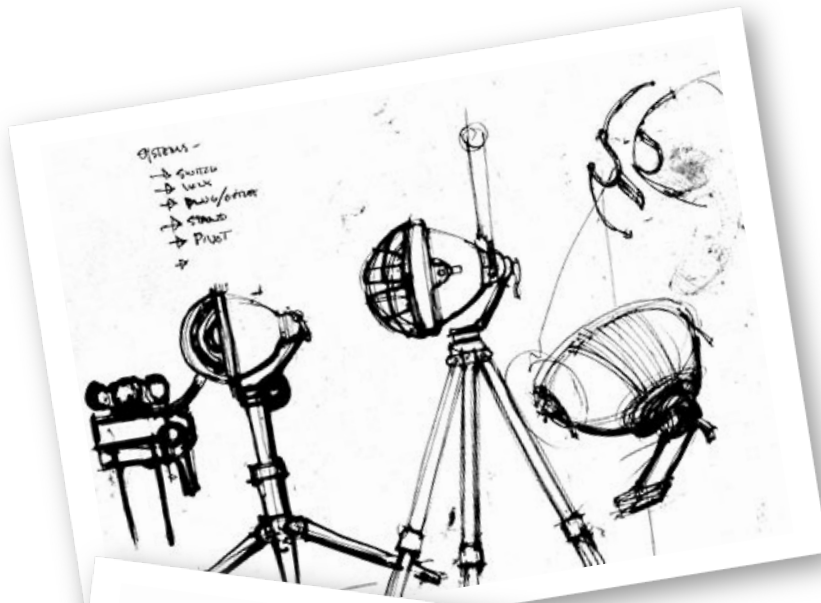

Worklight Sketch Notes,
Michael Davis Industrial
Designer
2001



Worklight Sketch Notes,
Michael Davis Industrial
Designer
2001



Fluorescent sconce
Heath Zenith, 1999



Exterior Porch Light,
Mercury Vapor,
Heath Zenith for Lowes,
1999

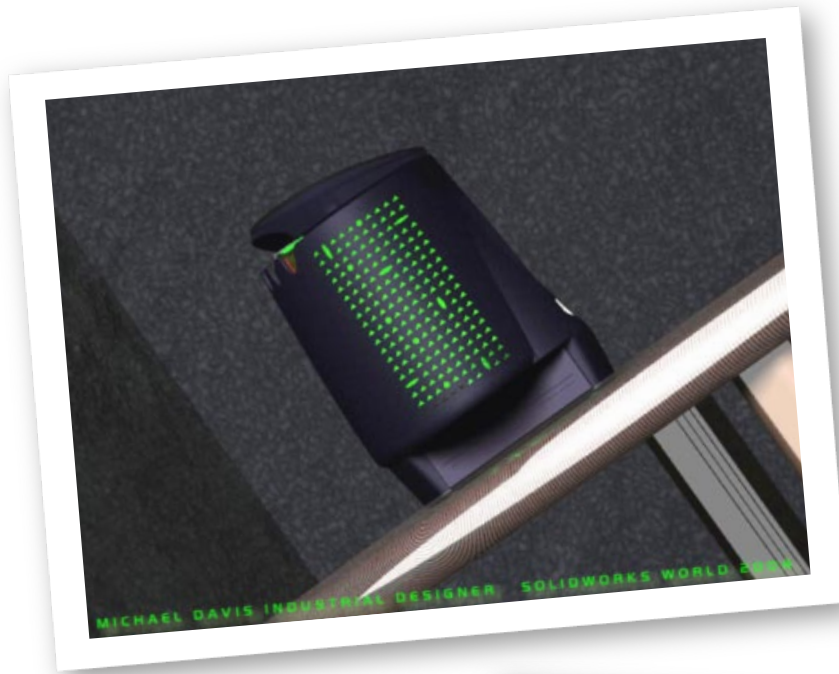

Computer Concept,
2003

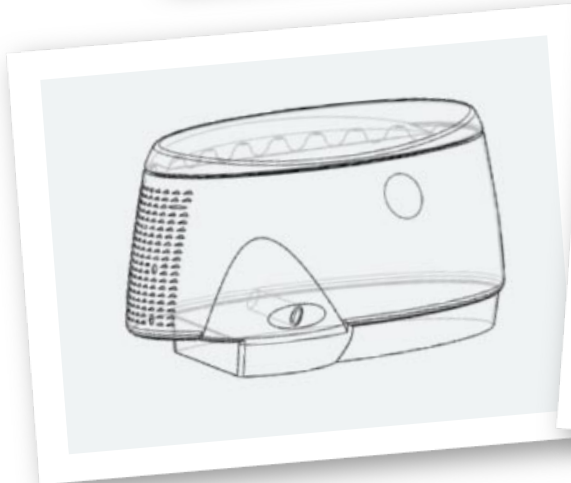

Computer Concept,
2003



Computer Concept,
2003

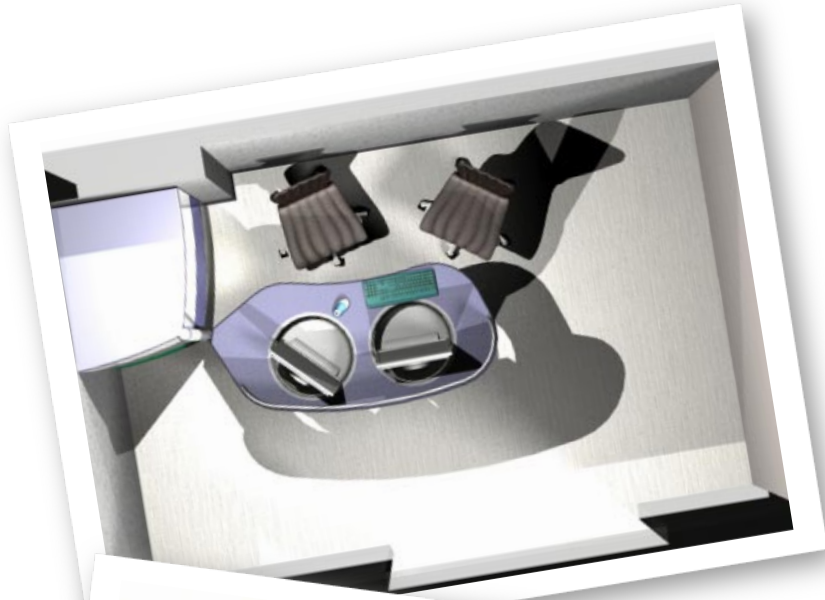

Proton Cancer Treatment
Control Room,
Optivus Inc, for Loma Linda
Hospital
2004

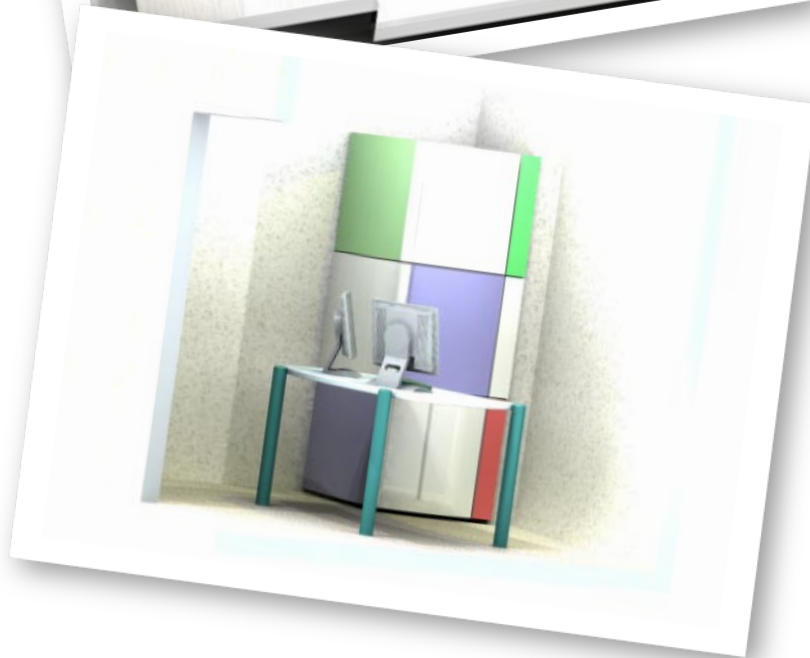

Proton Cancer Treatment
Control Room,
Optivus Inc, for Loma Linda
Hospital
2004



MICHAEL DAVIS INDUSTRIAL DESIGNER, 1996

Bioinjection Device,
Bioject Corporation
1995



Bioinjection Device,
Bioject Corporation
1995

Concepts

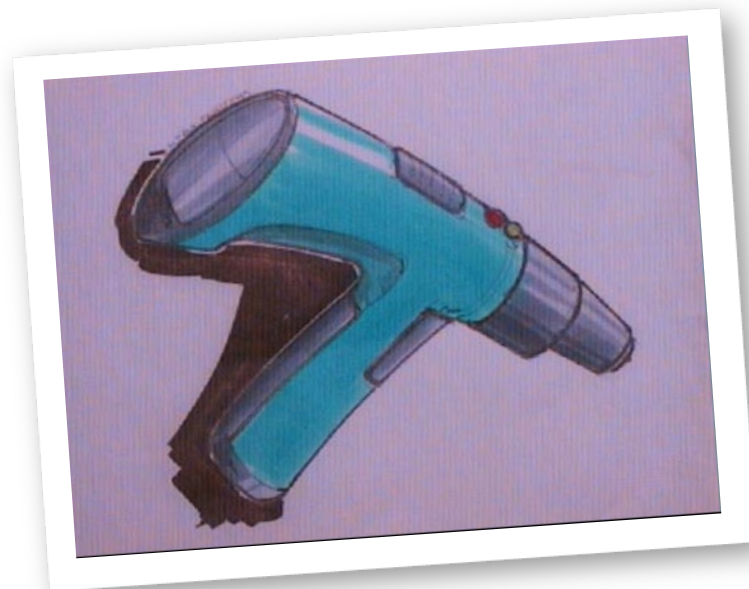



Bioinjection Device,
Bioject Corporation
1995

Hand made model



Bioinjection
Device,
Bioject
Corporation
1995

Concepts



Bioinjection
Device,
Bioject
Corporation
1995

Concepts



Bioinjection Device,
Bioject Corporation
1995

Hand made model

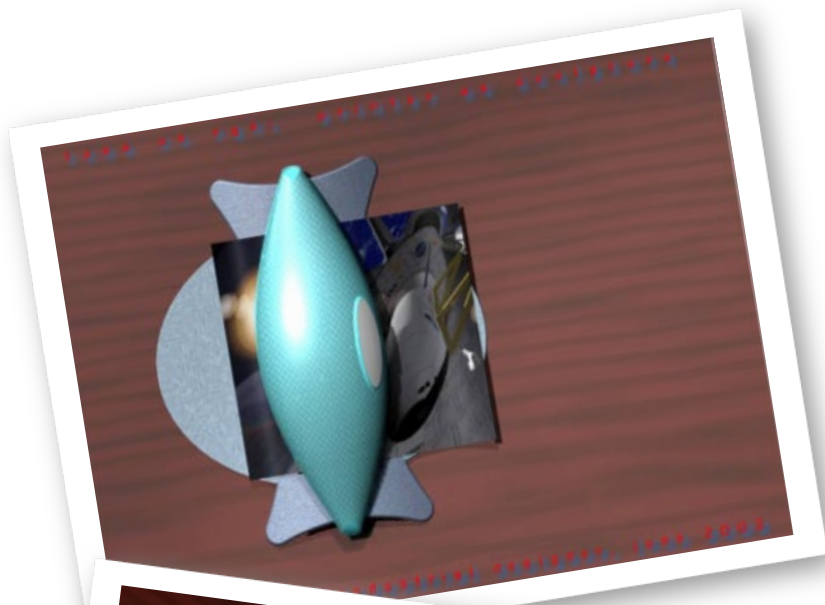

Tuna On Rye
Printer Concept
Michael Davis Industrial
Designer
2000

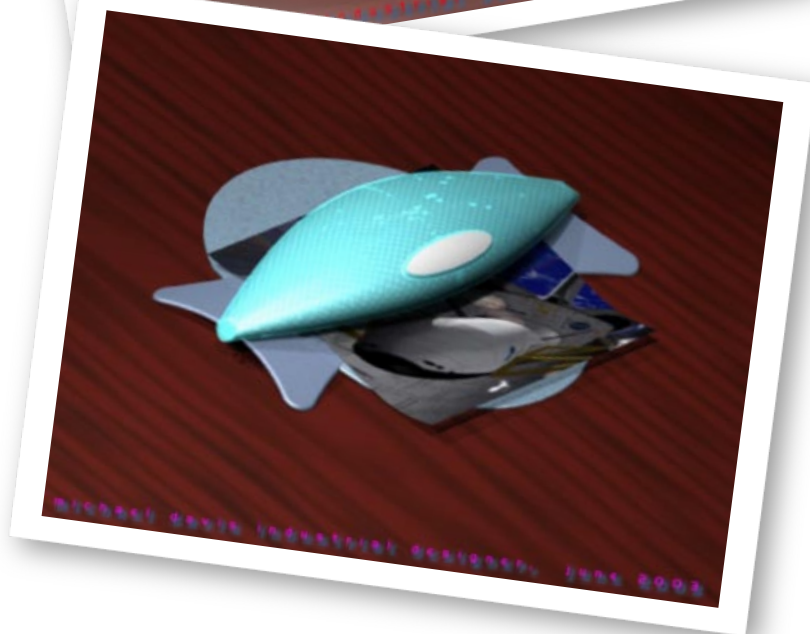

Tuna On Rye
Printer Concept
Michael Davis Industrial
Designer
2000